

# ALTAIR

FASHION BATHROOM LIFE

## M0124 Assembly instructions

1. Please read the instruction manual before installing and using the furniture.
2. Please assemble in strict accordance with the assembly instructions.
3. Please check carefully to ensure that all parts in the box are intact.
4. Please install it on the packing box to avoid damage to the product
5. Only use a rag or slightly damp cloth to clean the surface of the furniture, do not use strong scrubbing agents.
6. The use of unmatched hardware may cause damage to the product. Please confirm the specifications of various hardware accessories before installation.

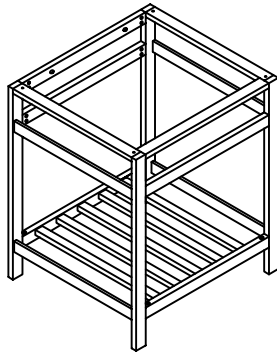
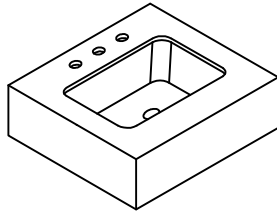

### Hardware accessories list

A



Fixing Screw X4

B



Hexagon Socket Screws X26

C



Allen Wrench X2

### Components

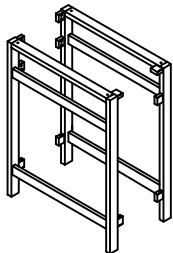

1 - side frames  
(1 left, 1 right)

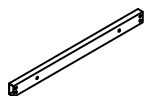

1 - Back pull strip

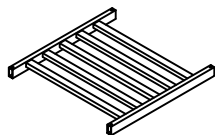

1 - Bottom frame

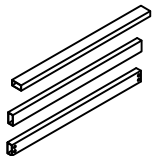

3 - universal pull strips

### Exploded general drawing

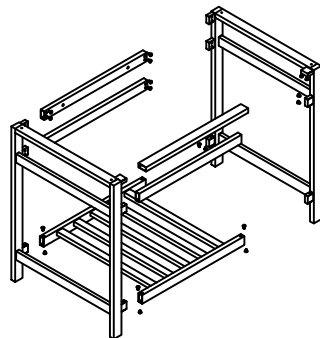

## Installation steps

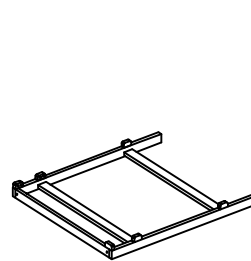

Step1:

First, lay the left border flat on the ground, paying attention to the paper skin on the pad

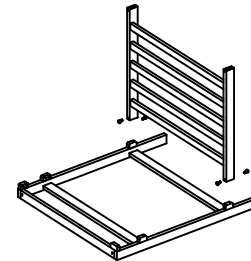

Step2:

The bottom shelf is then inserted into the frame and secured with hex screws

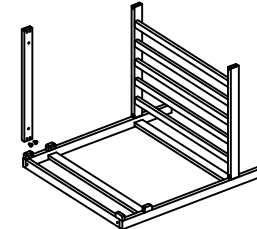

Step3:

Then slip in the rear pull-out bar

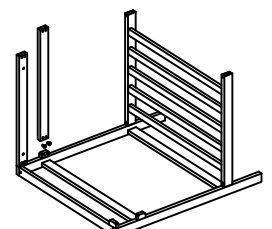

Step4:

Add universal pull strip

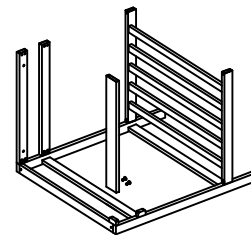

Step5:

Add universal pull strip2

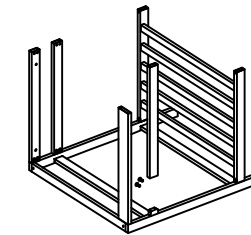

Step6:

Add universal pull strip3

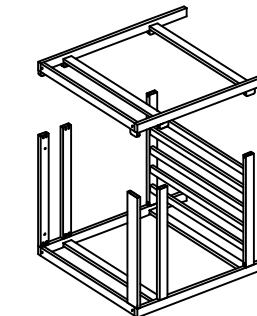

Step7:

Then put the right border in

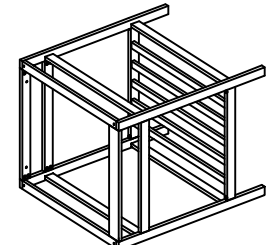

Step8:

Assembly complete

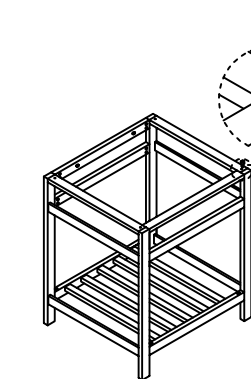

Step9:

Then arrange the cabinet and lock the positioning pieces

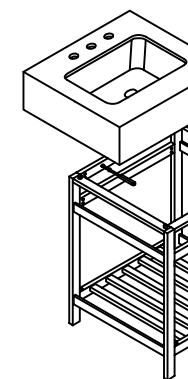

Step10:

The rear horizontal frame locks the wall, then add silicone to attach frame

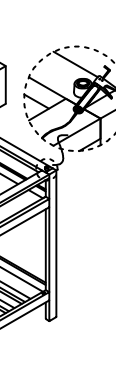

Step11:

Place the countertop on the frame and the installation is complete